

Art.no 482-42

FIRST USE

STEP 1.

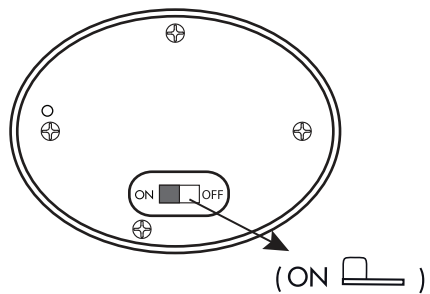

STEP 2.

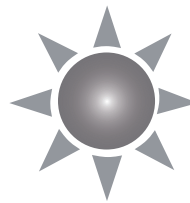

(ON )



(OFF )

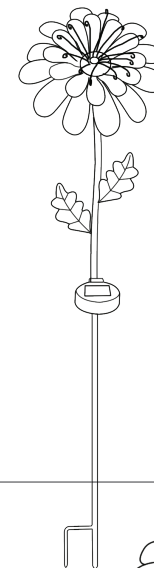

Ready after
36 h in the sun

BATTERY REPLACEMENT

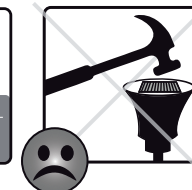
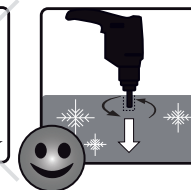
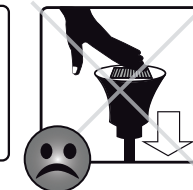
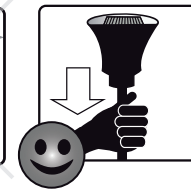
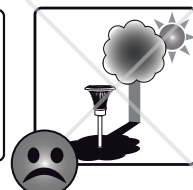
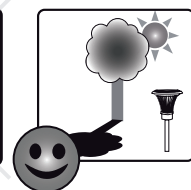
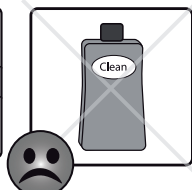
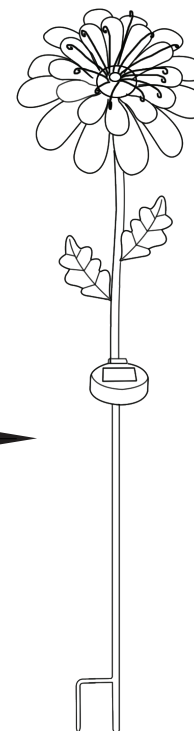
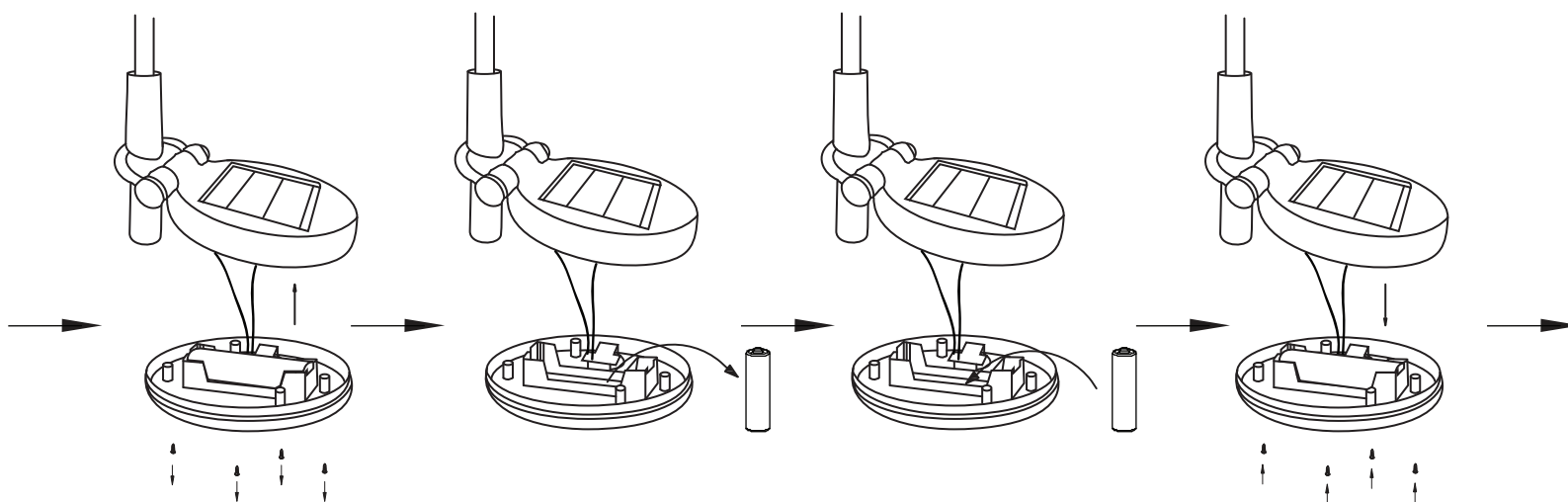
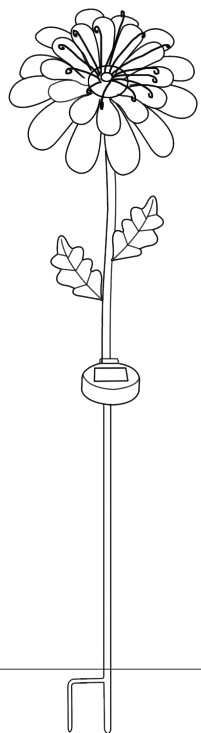

STAR[®]
TRADING
STAR STREET 1
512 50 SVENLJUNGA
SWEDEN
www.startrading.com