

Art.no 482-27

FIRST USE

STEP 1.

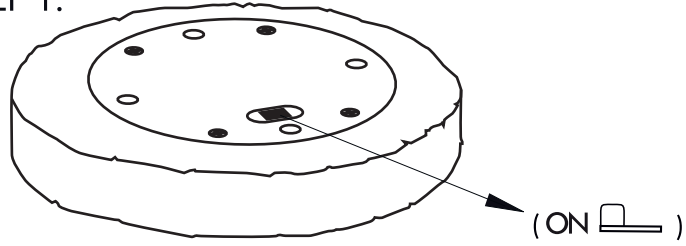

STEP 2.



(ON )

(OFF )

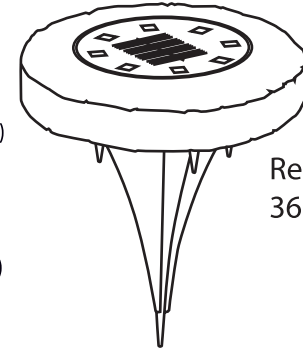

Ready after
36 h in the sun

BATTERY REPLACEMENT

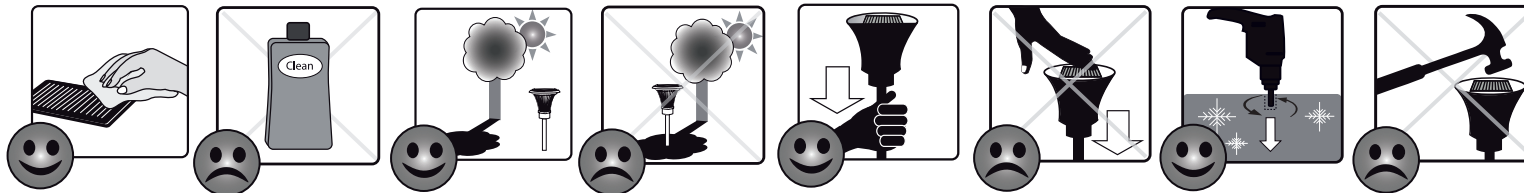
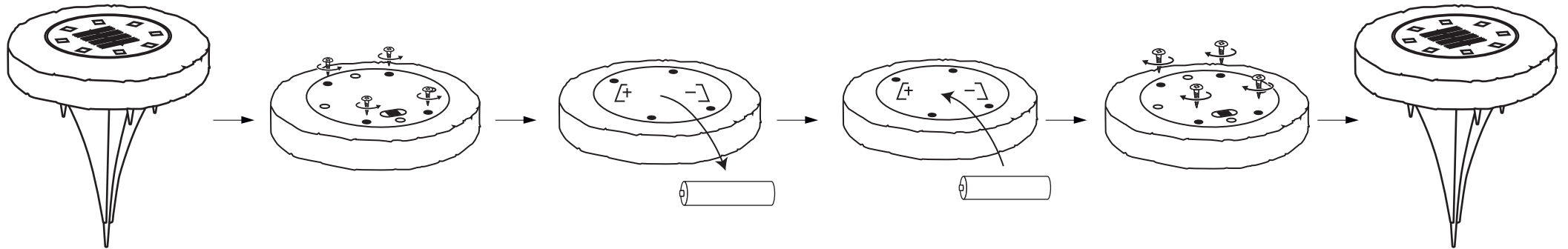

STAR[®]
TRADING
STAR STREET 1
512 50 SVENLJUNGA
SWEDEN
www.startrading.com

Art.no 482-27
ASSEMBLY
INSTRUCTION

STAR[®]
TRADING
STAR STREET 1
512 50 SVENLJUNGA
SWEDEN
www.startrading.com

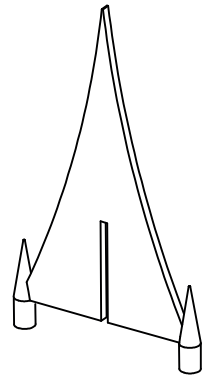

x1

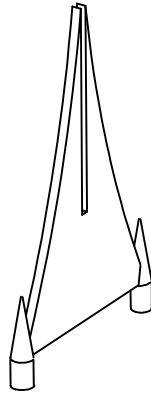

x1

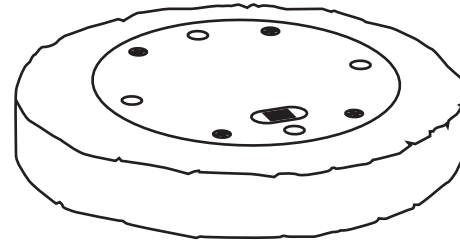

x1

