

Art.no 482-07

FIRST USE

STEP 1.

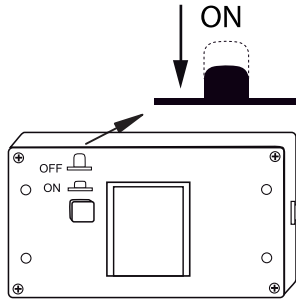

STEP 2.



Ready after
36 h in the sun

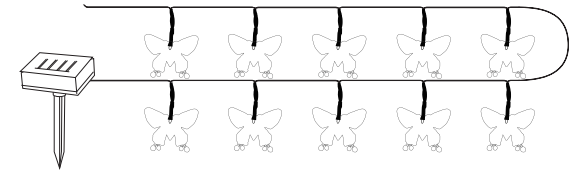

BATTERY REPLACEMENT

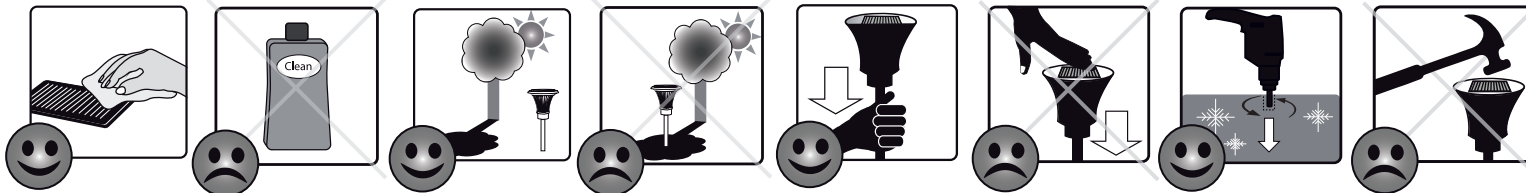
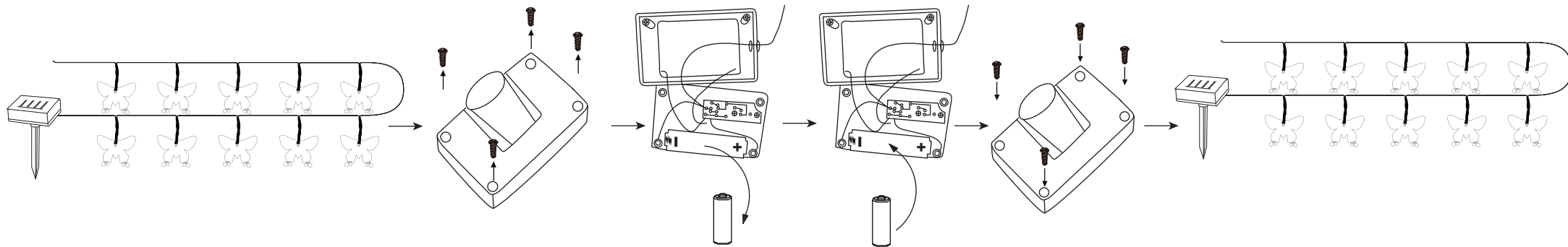

STAR[®]
TRADING
STAR STREET 1
512 50 SVENLJUNGA
SWEDEN
www.startrading.com