

Art.no 481-35

FIRST USE

STEP 1.

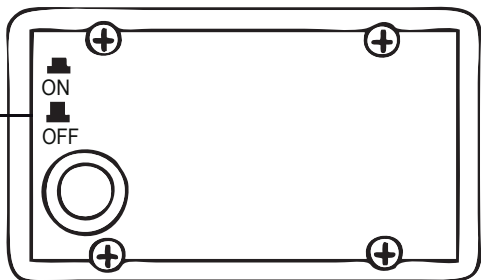
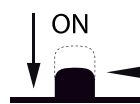

STEP 2.

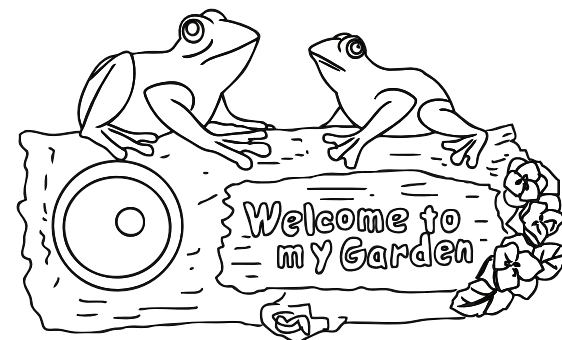
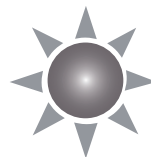

Ready after
36 h in the sun

BATTERY REPLACEMENT

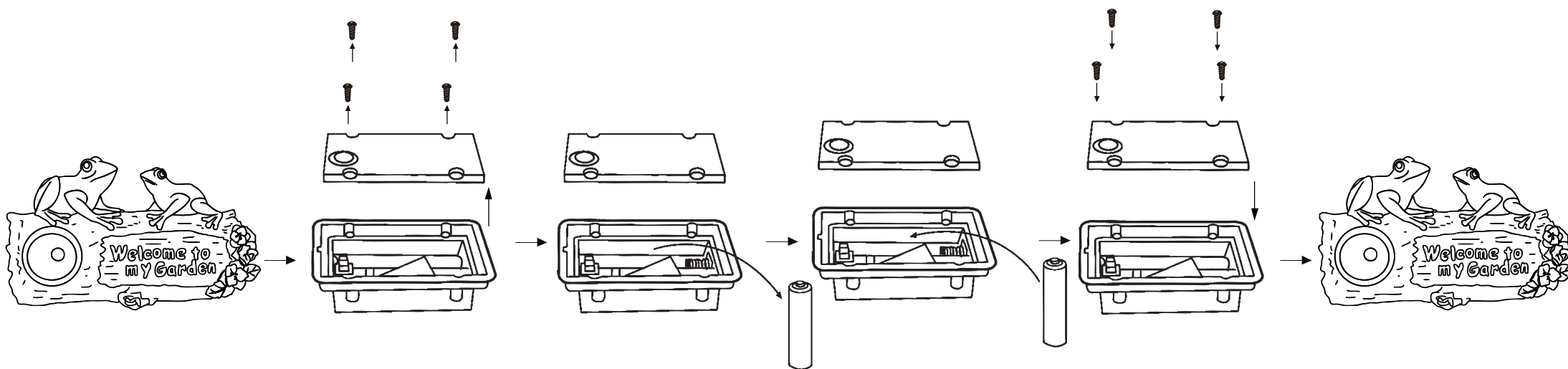

STAR[®]
TRADING
STAR STREET 1
512 50 SVENLJUNGA
SWEDEN
www.startrading.com